

Type TR60

Designed for the TR60+ and TR80+ profiles manufactured by Structural Metal Decks (SMD).



Wedge



Locking Plate

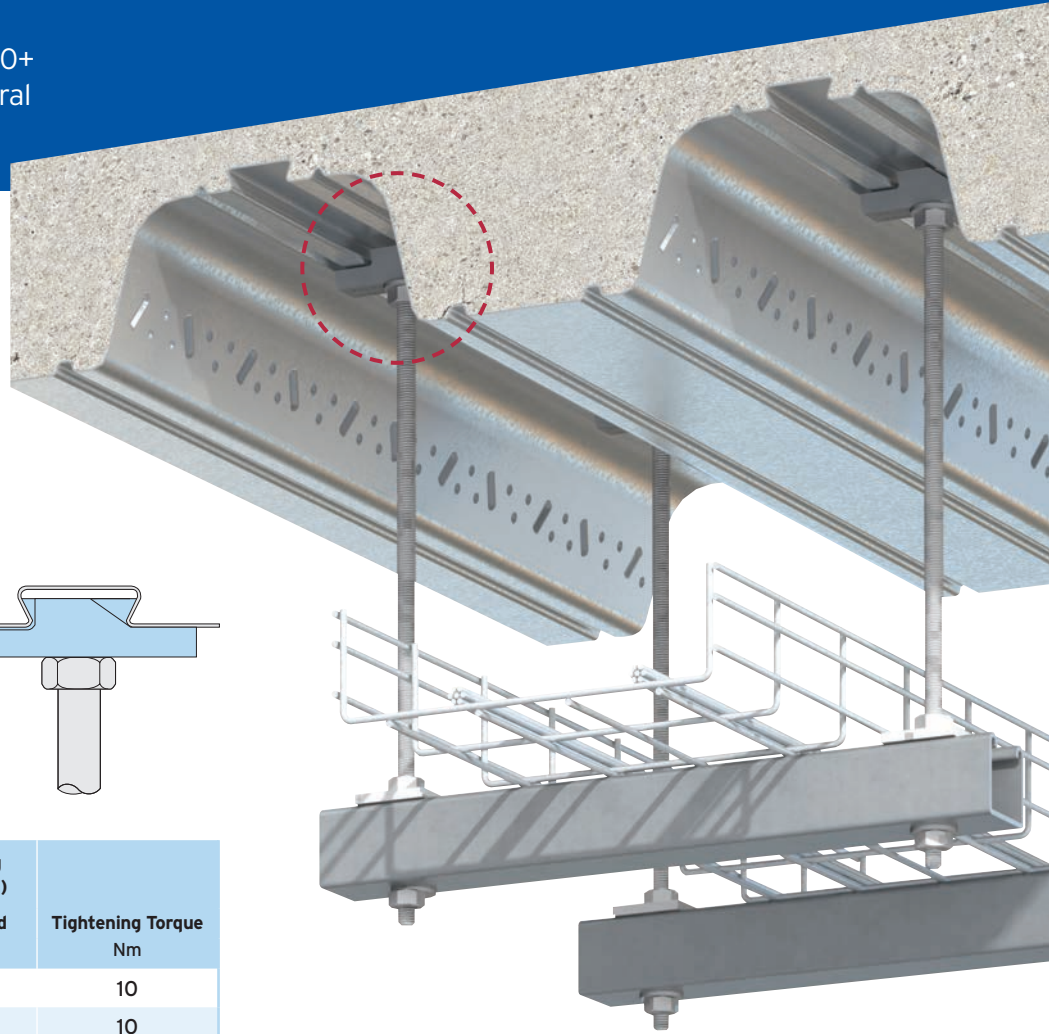
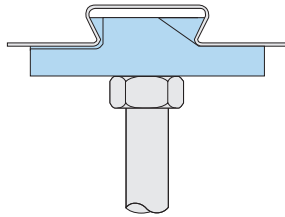

Locking Plate: Pre-galvanised strip.
Wedge: Malleable iron, bright zinc plated.

Product Code	Rod min 4.6	Safe Working Load (FOS 3:1)	
		Tensile / 1 Rod kN	Tightening Torque Nm
TR6006	M6	1.0	10
TR6008	M8	1.0	10
TR6010	M10	1.0	10



How to install...

▶ Watch the installation video at www.Lindapter.com

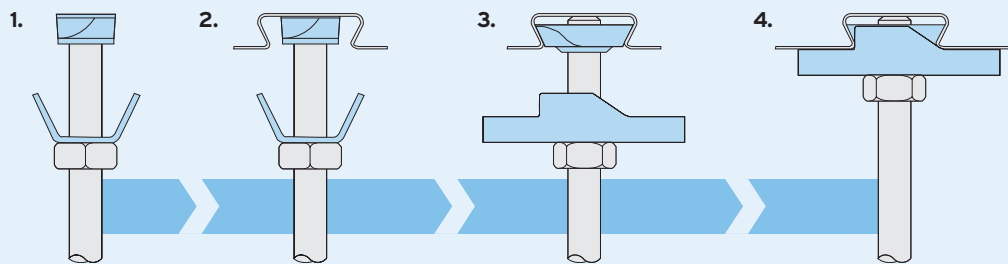

- 1) Pre-assemble the locking plate and wedge (flat surface up) onto the threaded rod.
- 2) Insert the wedge into the re-entrant channel of the decking.
- 3) Rotate until the chamfered cams engage on the sides of the channel.
- 4) Slide the plate up the threaded rod and over the wedge to lock it into position in the channel. Tighten the locknut beneath the plate to hold the assembly in position.









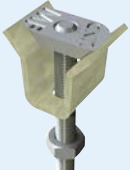
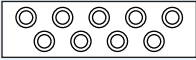
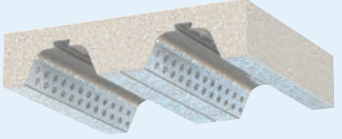

- ▶ Install the decking fixings after the concrete has been poured and has reached full strength.
- ▶ If the decking profile is deformed or distorted, do not install the fixing. If in doubt, contact the Technical Support team for advice.

GIRDER CLAMPS
 RAIL FIXINGS
 LIFTING POINTS
 HOLLO-BOLT
 FLOOR FIXINGS
 SUPPORT FIXINGS
 DECKING FIXINGS

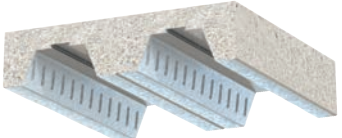
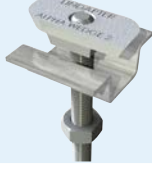
Product Comparison

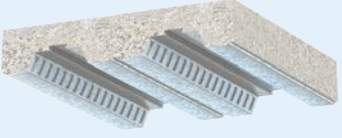
The table below shows the various components that are designed to fit the decking profiles of major manufacturers such as Composite Metal Flooring (CMF®), Kingspan® Structural Products and Structural Metal Decks (SMD).

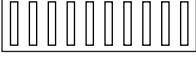
Components

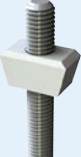
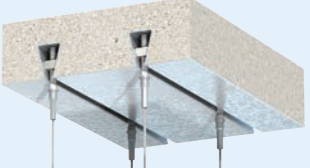
Lindapter Decking Fixing	Compatible Composite Decking Profile(s)
<p>Type TR60 page 64</p> 	<p>Structural Metal Decks (SMD) TR60+ and TR80+</p>  
<p>Type MF page 65</p> 	<p>Composite Metal Flooring (CMF®) MetFloor® 60 and MetFloor® 80</p>  
<p>Type MW2 - Multiwedge 2 page 66</p> 	<p>Kingspan® Structural Products Multideck® 60 and Multideck® 80</p>  
<p>Type AW - Alphawedge page 67</p> 	<p>Hare Decking (formerly Richard Lees®) Ribdeck® E60</p>  
<p>Type SD2 - Slimdek 2 page 68</p> 	<p>Tata Steel® Europe ComFlor® 225</p>  
<p>Type VN page 69</p> 	<p>Fits several profiles including: R51 (SMD), ComFlor® 51 (Tata Steel®), Holorib® (Hare Decking), Superib® (Hare Decking), Multideck® 50 (Kingspan®) and MetFloor® 55 (CMF®)</p> 

Also available

Type TC - Toggle Clamp
page 69



Designed for:

Service suspension from pre-cast hollow core slabs (minimum core depth of 75mm) as well as Structural Hollow Section (SHS), steel sheeting or purlins.

